

Edit Mixture Data

Entering Experimental Data of Mixtures in the Dortmund Data Bank

DDBSP – Dortmund Data Bank Software Package



DDBST

Dortmund Data Bank
Software & Separation
Technology

DDBST - Dortmund Data Bank Software & Separation Technology GmbH

Marie-Curie-Straße 10

D-26129 Oldenburg

Tel.: +49 441 361819 0

support@ddbst.com

www.ddbst.com

Contents

1. Introduction.....	3
1.1. Supported Data Banks.....	3
1.2. Working Mode.....	4
1.3. DDB Structure.....	4
1.4. Organization of Literature Data.....	5
2. Data Input.....	6
3. Common Options of EditMixtureData.....	6
3.1. Searching for Components.....	6
3.2. Searching for Literature.....	7
3.3. Plot Options.....	8
3.4. Loading from and Storing to the DDB.....	9
3.5. Restoring Overwritten Data Sets.....	10
3.6. Import/Export Options.....	11
3.7. Units and Qualities.....	13
3.8. Display Data Set in Dortmund Data Bank.....	13
4. Input Options Separated by Data Bank.....	13
4.1. VLE – Vapor-Liquid Equilibrium Data of Normal Boiling Substances.....	13
4.2. HPV – Vapor-Liquid Equilibrium Data of Low Boiling Substances.....	14
4.3. LLE – Liquid-Liquid Equilibrium Data.....	14
4.4. SLE – Solid-Liquid Equilibrium Data.....	15
4.5. AZD – Zeotropic/Azeotropic Data.....	16
4.6. ACT – Activity Coefficients at Infinite Dilution (Binary Systems).....	17
4.7. ACM – Activity Coefficients at Infinite Dilution (Ternary Systems).....	17
4.8. HE – Heats of Mixing Data.....	18
4.9. VE – Excess Volumes and Densities.....	18
4.10. CPE – Excess Heat Capacities.....	19
4.11. GLE – Gas Solubility Data.....	19
4.12. ELE – Vapor-Liquid Equilibrium Data of Electrolyte Systems.....	20
4.13. POW – Octanol-Water-Partition Coefficients.....	22
4.14. EGLE – Gas Solubilities in Electrolyte Containing Systems.....	22
4.15. CRI – Critical Data of Mixtures.....	22
4.16. ESLE – Salt Solubilities.....	24
4.17. AAE – Adsorbent/Adsorptive Equilibria.....	26
4.18. Polymers.....	28

1. Introduction

1.1. Supported Data Banks

EditMixtureData is the single editor for the mixture data banks in the Dortmund Data bank (DDB).

The supported data banks are currently:

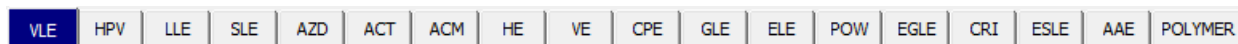

Figure 1 Data Bank Pages

Data Bank	Description
VLE	Vapor-liquid equilibria for high boiling substances (above 0°C)
HPV	Vapor-liquid equilibria for low boiling substances (below 0 °C)
LLE	Liquid-liquid equilibria (miscibility gaps)
SLE	Solid-liquid equilibria
AZD	Azeotropic and zeotropic data
ACT	Activity coefficients at infinite dilution for pure solutes in pure solvents
ACM	Activity coefficients at infinite dilution for pure solute in binary solvents
HE	Heats of mixing
VE	Excess volumes (volume effects of mixing), densities and volumes of mixtures
CPE	Excess heat capacities and heat capacities of mixtures
GLE	Gas-liquid equilibria (gas solubilities)
ELE	Vapor-liquid equilibria for electrolyte containing systems
POW	Octanol/Water partition coefficients
EGLE	Gas-liquid equilibria (gas solubilities) in electrolyte containing systems
CRI	Critical data of mixtures
ESLE	Solid-liquid equilibria for electrolyte containing systems (salt solubilities)
AAE	Adsorbent/adsorptive equilibria
POLYMER	Polymer data

Pure component properties are stored in the PCPDDB data base and the editor is “EditPureData”, a separate program described in its [own manual](#).

Many newer data banks, summarized under the term “Extended Data Bank” (XDDB), have also their own editor, the “XEditor”. A description of these data banks is available on DDBST's web site: <<http://www.ddbst.com/ddb-x.html>>.

1.2. Working Mode

EditMixtureData is directly working on the data banks – no intermediate files are involved. This is contrary to EditPureData which primarily works on files.

Additionally it is possible to load and store intermediate files in binary or formatted formats. These formats are not intended for editing in external editors.

This working mode has some advantages and some disadvantages:

- No extra step is needed for updating the data bank
- Original data in original units are not available any more – we recommend to use a spreadsheet program (Microsoft Excel, OpenOffice Calc, LibreOffice Calc for example) for keeping original data. EditMixtureData can easily exchange data with these programs by copy and paste.

1.3. DDB Structure

As this document uses some terms referring to the structure of the DDB some general information about the structure is given here.

There’s a global *configuration* that contains information used by all applications of the DDB Software Package (DDBSP).

Sample configuration:

```
@DDBPTH=F:\DDB\
@DDBPRV=F:\PRIVATE\
@DDBSCR=F:\SCRATCH\
@DDBTRC=ON
```

A sample contents of this file is shown here:

The entry DDBPTH points to *public folder*, the directory holding *public data* (provided by DDBST GmbH).

The entry DDBPRV is set to the location of the *private folder* (containing data maintained by customers only).

The entry DDBSCR determines the *clipboard directory*, which will be used by DDBSP applications to exchange input and output files as well as temporary files. Sometimes files created there contain additional information not displayed by the programs.

The configuration can viewed and altered with the program “DDB Configuration”.

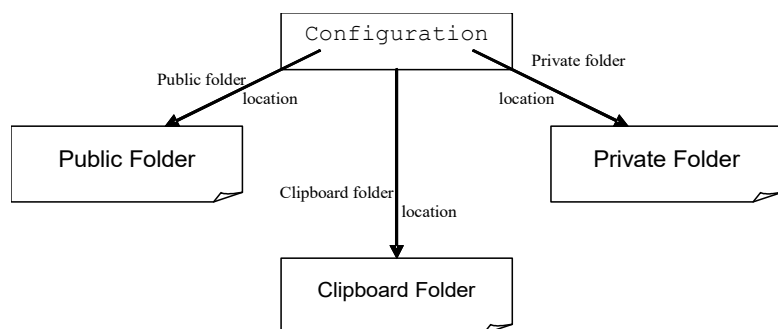

Figure 2 Rough Structure of the DDB folders

Figure 3 shows in more detail how the mixture data banks are organized within the DDB. Published experimental data refer to *components* (defining the system) and *literature data* (representing the paper containing the data). The DDB contains a large component list as well as a large list of literature data sets. These are physically organized outside the mixture data banks.

Experimental data provided by DDBST will refer to public components and public literature only. Customer’s data may also refer to private (user-defined) components and private literature.

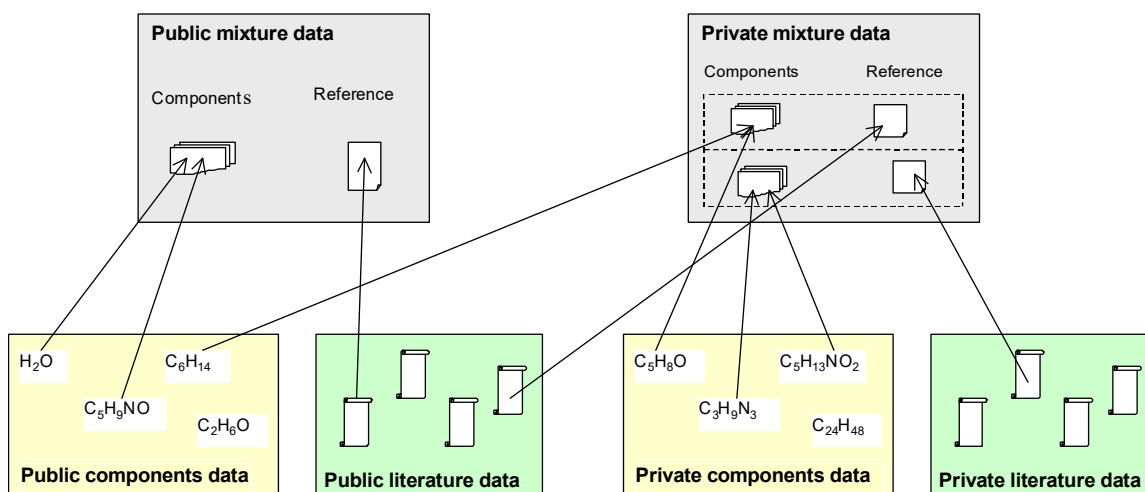

Figure 3 Organization of Literature Data

As everything denoted as *public* is provided by DDBST and all (unreported) changes done to public data will be eradicated with an update this document will focus on the maintenance of *private data*.

1.4. Organization of Literature Data

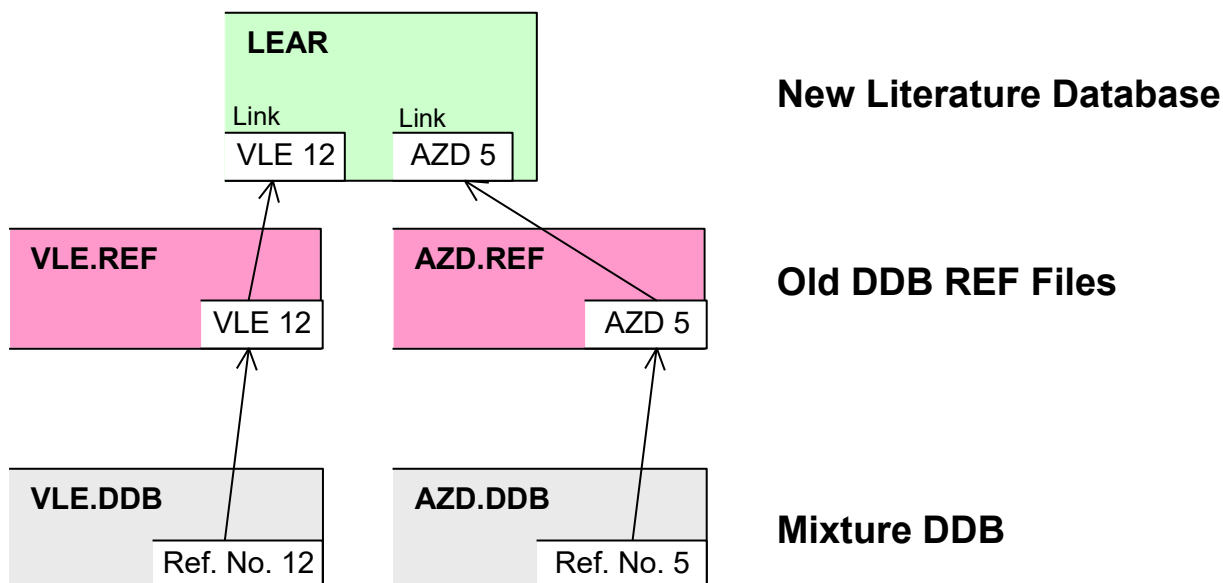

Figure 4 Organization of Literature Data (Example)

As an example we assume an article that contains both VLE and AZD experimental data. The evaluation will result in two data bank entries: one in VLE.DDB and one in AZD.DDB. The reference number organization in the mixture data bank uses different lists of references for every data bank. So this will result in two entries in the old references data bank (VLE.REF and AZD.REF, both reference lists start from reference no 1). But these files exist for backward compatibility only. Instead the article will be referenced only once inside LEAR (representing both REF entries). As there is a reference number stored in a mixture data set there must be an association between a LEAR data set and all reference numbers belonging to it. This is done by adding a so-called *link* to the LEAR data set. In this example a link to REF VLE 12 and REF AZD 5 will be added.

2. Data Input

Since the data sets only contain references to components and literature information it is necessary to add component and literature information prior to the experimental data.

Adding new literature information is described in [LEAR documentation](#). Adding new component information is described in the [component management documentation](#).

3. Common Options of EditMixtureData

3.1. Searching for Components

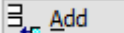
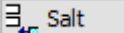

Figure 5 Component Box

Pressing the  **Add** or the  **Salt**

button invokes the ComponentSelection program either for 'normal' components or for salts. In both cases it is possible to switch to the other list and to the other types of components which are adsorbents and polymers for the data banks containing salts (ELE, else), adsorbents (AAE) and polymers.

The edit field below the 'Salt' button allows to type DDB component numbers if they are known.  **Replace** calls the ComponentSelection program and replaces the currently selected line (component, salt, and adsorbent). The selection of components is described in the [component management documentation](#).

After selecting two normal components and a single salt the component box looks like this:

4	C	DDB		Acetone
44	C	DDB		1-Chloro-2-methylprop
7	S	DDB		Barium bromide

The green column contains the component numbers, the light yellow column contains a “C”, a “S”, or an “A” for the three types normal components, salts/electrolytes, and adsorbents.

The  **Remove** button removes the component/salt/adsorbent and the pink column contains the name.

Depending on the currently selected data bank type not all components will be used for input. All unused components will be marked by a gray color.

4	C	DDB		Acetone
44	C	DDB		1-Chloro-2-methylprop
7	S	DDB		Barium bromide

The order of the components can be changed by drag-and-drop (moving the mouse while keeping the left mouse key pressed).

4	C	DDB	Remove	Acetone
44	C	DDB	Remove	1-Chloro-2-methylprop
7	S	DDB	Remove	BARIUM BROMIDE

Figure 6 Start

4	C	DDB	Remove	Acetone
44	C	DDB	Remove	1-Chloro-2-methylprop
7	S	DDB	Remove	BARIUM BROMIDE

Figure 7 Move/Drag

4	C	DDB	Remove	Acetone
7	S	DDB	Remove	BARIUM BROMIDE
44	C	DDB	Remove	1-Chloro-2-methylprop

Figure 8 Drop/Result

The same reordering can be performed by the arrow keys <▲> and <▼> while holding down the Control (Ctrl) key.

3.2. Searching for Literature

If a literature is already available it can be searched via the search button () in the “Reference” block. The search query dialog contains two search modes, a quick search mode and an advanced search mode. We will show a quick search for the author “Gasem” and the year 2001 (see Figure 9).

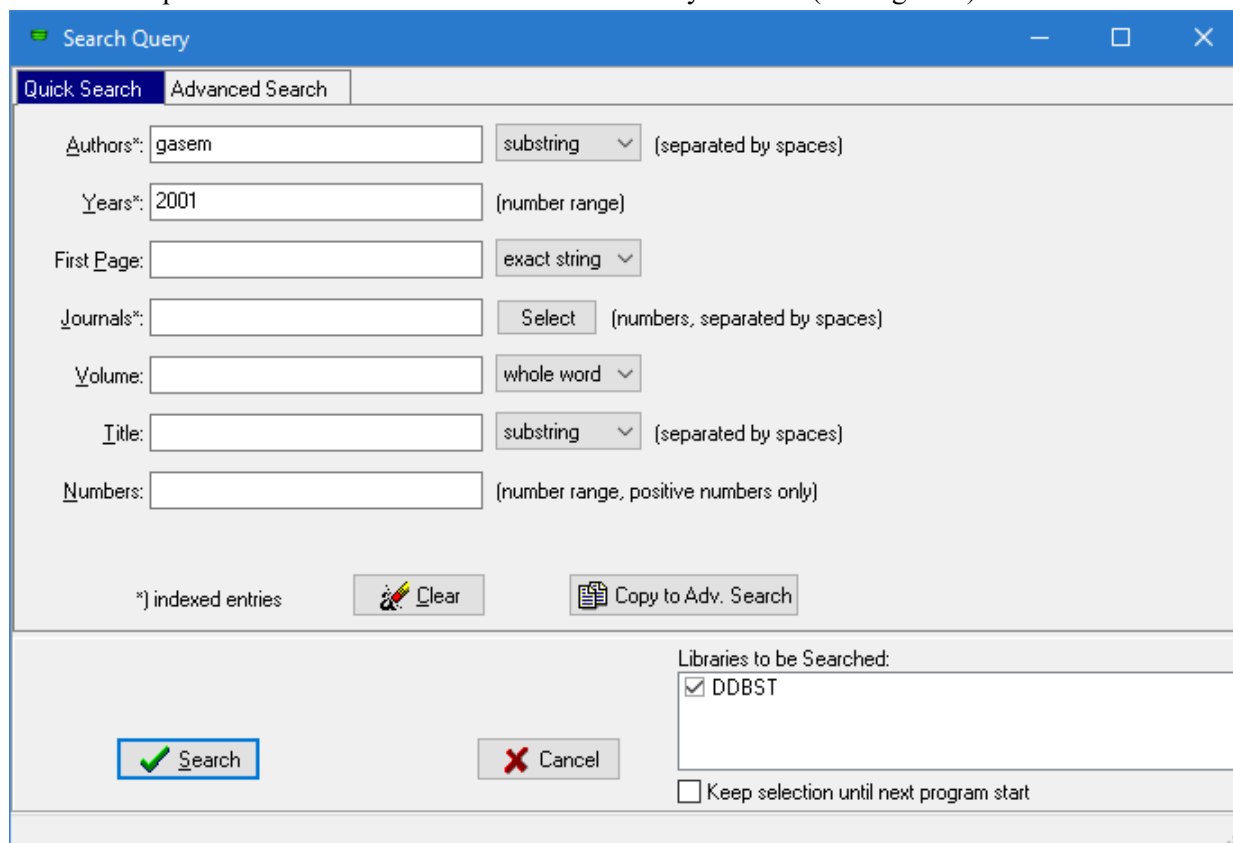

Search Query

Quick Search | Advanced Search

Authors*: gasem substring (separated by spaces)

Years*: 2001 (number range)



First Page: exact string

Journals*: Select (numbers, separated by spaces)

Volume: whole word

Title: substring (separated by spaces)

Numbers: (number range, positive numbers only)

*) indexed entries  Clear  Copy to Adv. Search

Search Cancel

Libraries to be Searched:
 DDBST
 Keep selection until next program start

Figure 9 Quick Search Query

After selecting one of the found data sets () EditMixtureData will display the LEAR number and some information about the selected reference.

LEAR #	Details
30608	 [30608] Shaver R.D., Robinson R.L., Gasem K.A.M., Fluid Phase Equilib., 179, 43-66, 2001

If a LEAR number is known it can be directly typed in the “LEAR#” edit field. After accepting the input by pressing enter EditMixtureData shows the details.

3.3. Plot Options

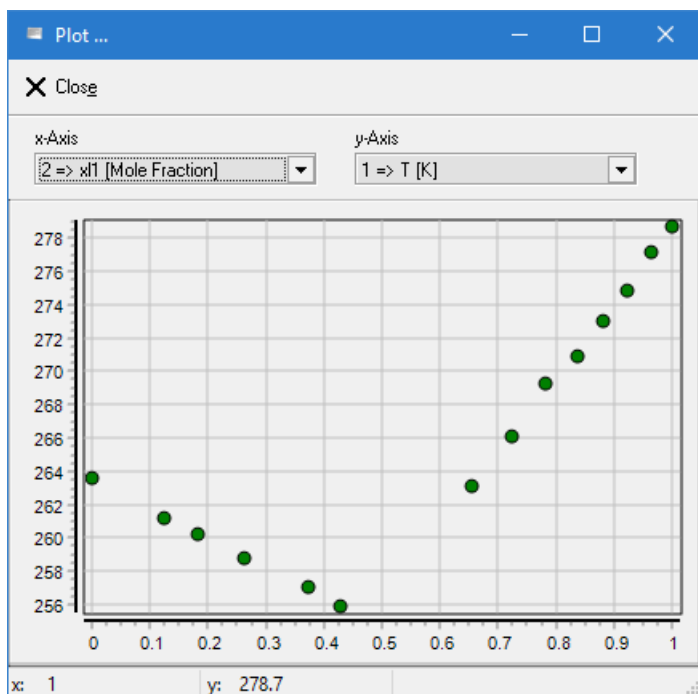
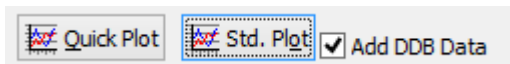
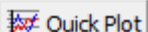

Figure 10 Quick Plot

To receive a quick overview about the just edited data the quick plot option

( Quick Plot) can be selected.

The integrated plot of EditMixtureData only allows to plot two data columns against each other.

The selected columns can be changed by the combo boxes:

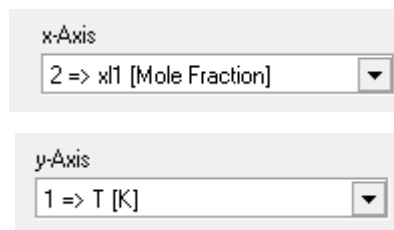

The status bar displays the x and y data for the point which is next to the mouse cursor indicated by a rubber band.

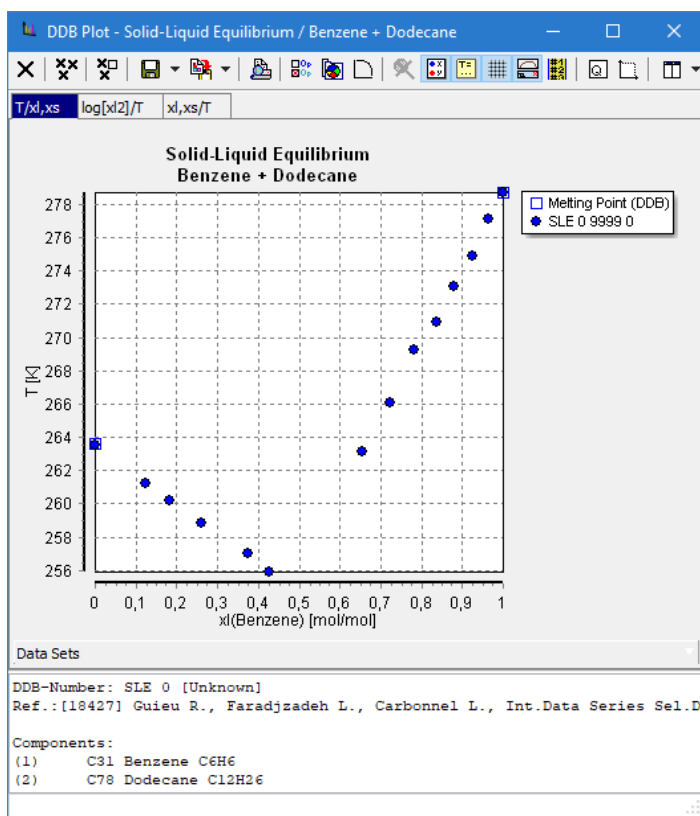
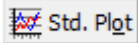

Figure 11 Standard Plot

The standard plot  calls the plot program normally used. This plot program automatically selects the generally used plot types for the current data sets.

It displays the components, the reference and also the point's data which is next to the mouse cursor in the status line.

For this plot it is possible to include already stored data. Check

Add DDB Data

to activate this option.

3.4. Loading from and Storing to the DDB

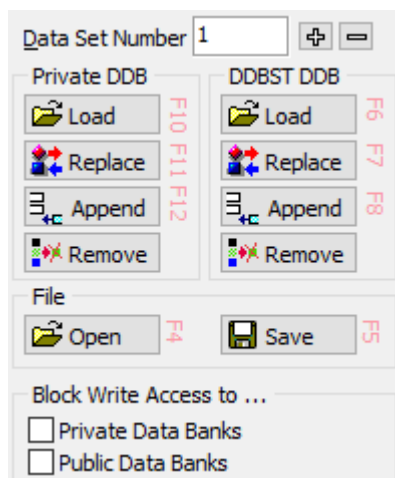

EditMixtureData stores and reads data sets directly from the data banks.

There are two groups of buttons, one for the private (customer's) and the public (DDBST's) database.

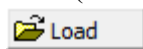

To change an existing data set (or to use its data as basis for a new data set) use the appropriate *Load* button. Before loading a data set from the (private) DDB be sure that the correct data bank tab is selected. "Load" will always fetch the data set specified in the field.

There are two possibilities to put a data sets directly into the (private) DDB: A data set can either replace an existing data set or it can be appended to the data bank, leaving all other data sets untouched.



The *Replace* option is intended for corrections of existing data sets. But it is, of course, possible to replace an existing data set by a complete new data set. Before replacing a data set a confirmation dialog will prevent the user from accidentally messing up the data bank and additionally every overwritten data set is saved in a “Roll Back” file.

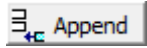

To add a new data set to the (private) DDB use the *Append* option. If the data bank does not exist so far, a brand new will be created and the current data set will be added as first (and only) data set. Anyway, the *Data Set Number* field will be updated to the new number.

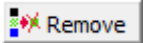
The “Remove” button  deletes the data set specified in the *Data Set Number* field from the current database.

3.5. Restoring Overwritten Data Sets

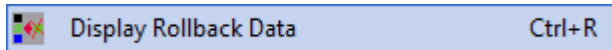

Every replaced and overwritten data set is saved in a roll-back file. These saved data sets can be restored from this list.

The dialog displays the entire list of overwritten sets. The view on the list can be restricted to single data banks, single users, single locations (private or public DDB) and, the most effective filter, the data set number.

Data bank, data set number, location, data and time of overwriting, and the user is displayed.

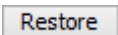
The  button allows to restore the selected data set. The data set which is now replaced by the old data set will be stored in the roll-back file.

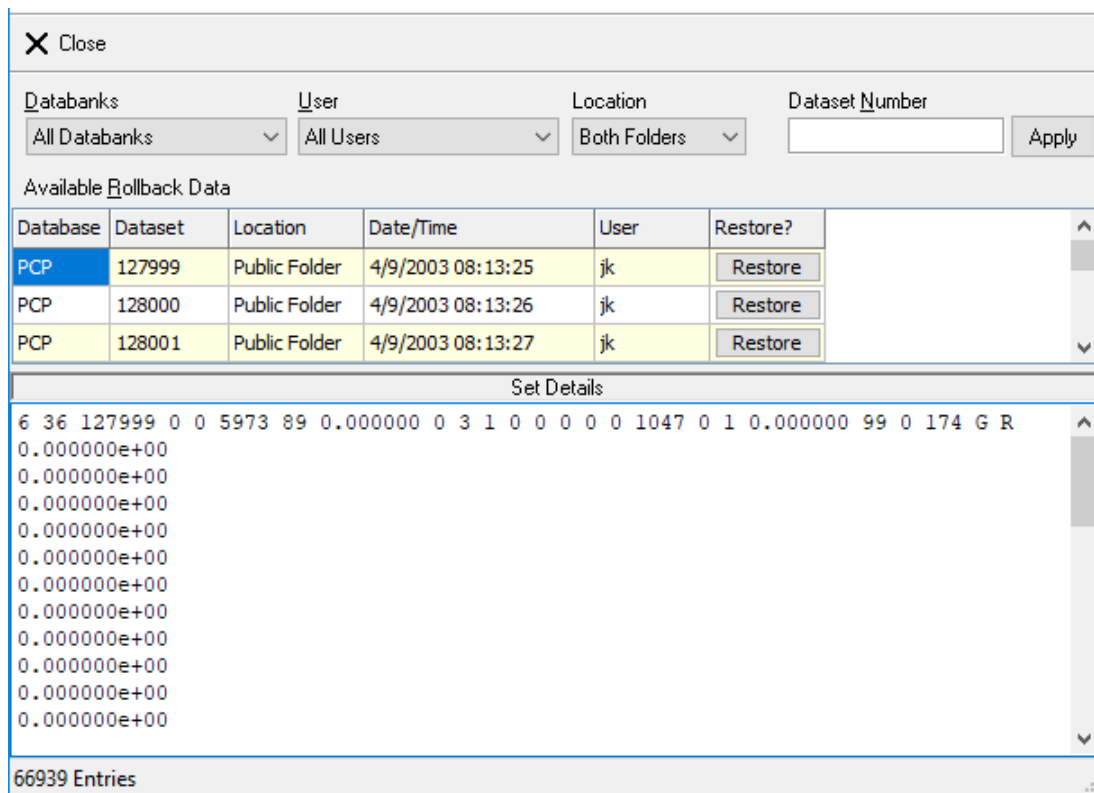
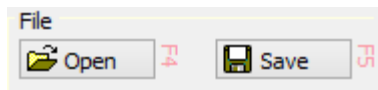

Figure 12: Rollback Dialog

3.6. Import/Export Options



Data sets can be written or loaded from interface files in several formats. All file formats are currently proprietary formats of DDBST.

- Query Result File
This is almost the old “Free Formatted DDB Interface File” but extended by a database information. This format should be used wherever possible. The extension is “.qr”.
- Binary DDB Interface File
This is a legacy file format normally used by old DOS programs in the DDB software package.
- FORTRAN 77 Formatted DDB Interface File
This is another legacy file format. This file format can only be read. It contains text information but is formatted very dense which makes it hard to read.
- Data Handling Program File
This format is very similar to the FORTRAN 77 formatted file and has been used by some DOS programs. This format can only be read.
- Free Formatted DDB Interface File
This is the new standard file format.

- Original Units File

For some databases it is possible to store the typed data in original units.

Several of these files can contain multiple data sets. If such a file is loaded a special dialog displays the complete list of found data sets.

This dialog shows the database, the given number of data points, the component list (as DDB numbers) and the reference number (links).

It is possible to edit the single data set () or to append all sets either in the public or private data bank.

If the data bank contains removed data sets they are listed in the “Empty Sets” list and will be overwritten if the “Fill Empty Sets” box is checked.

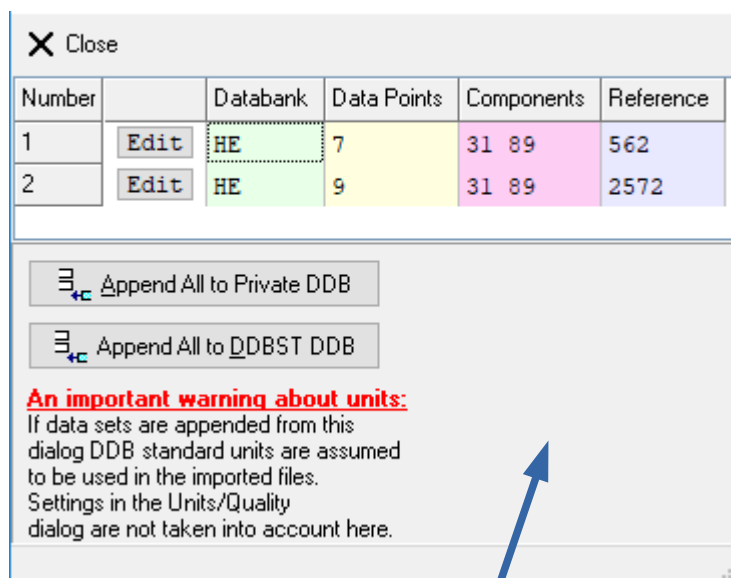
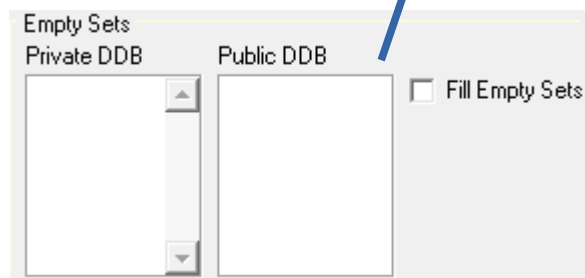

Figure 13 List of loaded data sets



Remark:

VLE/HPV data saved in the same binary format having the same file extension. So the program can not differ between these two types. The user has to select the right data bank tab before loading data of one of these two types. All other binary types are recognized automatically.

Select the button to store a data set as file on disk. Depending on the extension selected in the file open dialog the file is either stored in text or in binary mode. If the data is stored as binary file the data type is automatically recognized by Mixture Properties using the file extension. This is also true for the “.qr” query result files.

3.7. Units and Qualities

The input units information – also containing selection boxes for data quality and source descriptions – is displayed in the lower right area of the main window.

When switching to another database the program displays the standard units initially.

Some databases have their own unit description (GLE for example). In this case the selection box is grayed out.

3.8. Display Data Set in Dortmund Data Bank

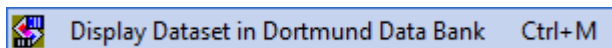

This function transfers the currently edited data set to the main Dortmund Data Bank program without storing it to the data bank before-hand.

This allows the usage of the entire functionality of the Dortmund Data Bank program like extended plotting, estimation, fitting, exporting, and more.

4. Input Options Separated by Data Bank

It is recommended to select the appropriate data bank before selecting components or literature.

4.1. VLE – Vapor-Liquid Equilibrium Data of Normal Boiling Substances

Select the VLE tab above the edit field to enter vapor-liquid equilibrium data for systems containing components with a boiling point above 0 °C. The number and heading of the input columns will be set automatically by (de-)selecting of components and the other options described below.

The maximum number of components in a system is four.

Data Type	1	2	3	4	5	6	7	8	9
	x	y	P	T=constant					
1	x	y	P	T=constant					
2	x	y	T	P=constant					
3	x		P	T=constant					
4	x		T	P=constant					
5	x	y		T=constant					
6	x	y		P=constant					
7		y	P	T=constant					
8		y	T	P=constant					
9	x	y	P	T					

As first configuration in the data sheet the desired data type has to be selected.

There are currently nine data types defined. They specify which phases are given and if there's a constant pressure or temperature for the whole data set.

The liquid phase is denoted 'x' and the vapor phase is denoted 'y'.

For values 1 to 8 a constant condition is given for all data points. So a value and the value's unit has to be entered.

A composition is always given in mole fractions. The value for the last component in the system can (and has to) be omitted.

If no constant temperature or pressure given for the whole data set, then data type 9 has to be selected. With this selection a second “Non-Constant Unit” field will appear. It is also possible to specify which measured quantity is really given. In this case a special option can be used to define a (pseudo) constant column. By this it is allowed either to specify a constant value for one phase or to state that the deviation of the values of one column is small.

Although any data classified as type 1-8 can be seen as special type 9 data it is recommended to avoid the usage of this data type. The data types one or two should be used as often as possible, because most calculation routines are optimized for them.

The VLE editor allows also performing consistency tests, swapping components, fitting g^E model parameters (for test purposes here), and starting the evaluation if the entered VLE data show azeotropic behavior. The “fit” option is only available if the appropriate calculation software has been licensed.

4.2. HPV – Vapor-Liquid Equilibrium Data of Low Boiling Substances

Select the HPV tab to edit vapor-liquid equilibrium data for systems containing components with boiling points below 0 °C. The options are mostly the same as for VLE data. Only the pressure and temperature units used in the DDB are different.

The differentiation between the VLE and the HPV data bank is arbitrary and has only some historic and commercial reasons. Data from both data banks are handled the same way throughout the DDB software package.

4.3. LLE – Liquid-Liquid Equilibrium Data

To edit liquid-liquid equilibrium data (miscibility gap information) the LLE tab has to be selected. It is recommended to select the desired system and literature data set before configuring the data sheet itself. The selected literature data set must be prepared for use with the LLE data bank. The maximum number of components in a system is five.

The input of this kind of data differs much from editing e.g. VLE data. For example no predefined data types are used. Instead the table entries are selected directly.

All the settings described below (and the number of components) control the number of columns in the data grid.

The **Table Entries** specify the measured quantities. It is not possible to specify a constant environment condition directly. In this case the constant value has to be entered in any row of the data grid.

Pressure Type

Equilibrium (VLE)

non-Equilibrium

Not specified

If a pressure is given, then the **Pressure Type** has to be specified. If unsure **Not Specified** should be selected.

Number of Phases

2

If there are three or more components in the system, then up to three liquid phases may be specified in the field **Number of Phases**. A possibly given vapor phase is not counted here.

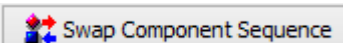
The  button reverses the component sequence and also exchanges the columns in the data table.

4.4. SLE – Solid-Liquid Equilibrium Data

Select the SLE tab above the edit field to enter solid-liquid equilibrium data (solubility information) and add it to the SLE data bank. The number and heading of the input columns will be set automatically by (de-) selecting of components and the other options described below. It is recommended to select the desired system and literature data set before configuring the data sheet itself. The selected literature data set must be prepared for use with the SLE data bank. The maximum number of components in the system is four.

Dataset Entries

1 - T x_l (P)

2 - T x_s (P)

3 - T x_l x_s (P)

4 - T x_l x_s y (P)

5 - P x_l (T)

6 - P x_s (T)

7 - P x_l x_s (T)

8 - P x_l x_s y (T)

9 - T P x_l x_s y

The desired data type can be selected in the *Data Set Entries* field. There are currently nine main types defined which are described below.

‘T’ denotes a temperature is given. ‘x_l’ is an abbreviation for mole fraction in the liquid phase. ‘x_s’ means mole fraction in the solid phase. ‘y’ is for mole fraction in gas phase. A symbol is listed in brackets denotes an environment condition valid for all data points.

Constant

101

For the data types 1 to 8 a constant condition (either temperature or pressure) is given for all data points. A constant value has to be specified. The value’s unit is selected in the “Units/Quality” dialog.

Dataset Entries

9 - T P x_l x_s y

Available columns:

P T x_l x_s y

(Almost) Constant:

P T x_l x_s y None

There is a reserved data type (9) to specify that neither a temperature nor a pressure as constant environment condition is given. This data type 9 can also be used if P/T is unknown for any data point. Selecting this data type will make up to two *Non-Constant Unit* fields to appear. Again, it is possible to define one (almost) constant column.

Although any data classified as type 1-8 can be seen as special type 9 data it is recommended to avoid the usage of this data type. Most of the plot and calculation routines will only work with the data types 1-8.

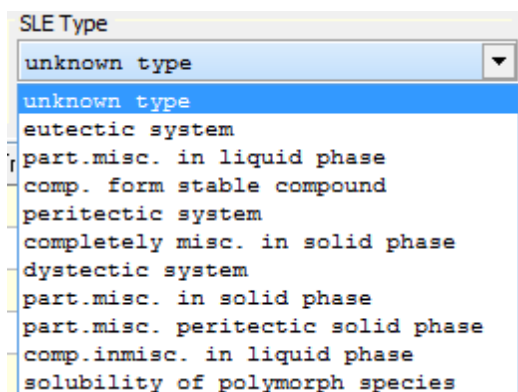

Several classifications are available in the *SLE Type* drop-down list. If unsure “*unknown type*” should be selected. The “Statistics” button reads all SLE data sets and display the number of data sets for the different data types.

4.5. AZD – Zeotropic/Azeotropic Data

To edit azeotropic/zeotropic data the **AZD** tab has to be selected. It is recommended to select the desired system and literature data set before configuring the data sheet itself. The selected literature data set must be prepared for use with the AZD data bank. The maximum number of components in the system is four.

Any data set in the AZD data bank contains just one data point. It is possible to specify a temperature, a pressure and (if an azeotrope exists) a composition. If no temperature, no pressure or no composition is given, then the corresponding option should be unchecked.

Furthermore some additional information can be specified. These will be described below.

Type of Azeotrope: If beyond the fact that there’s an azeotrope no further information is known, then this field should be left empty.

To specify that there’s *no azeotrope* (maybe under certain environment conditions) for the given system *none* can be selected. Of course this will exclude a detailed specification of the azeotrope described below.

Selecting *Pmax* resp. *Pmin* will specify a pressure maximum resp. minimum azeotrope, where *Saddle* specifies a saddle point.

If there exists a miscibility gap under the given environment conditions *MisGap* should be selected.

Enabling *2azd* specifies the existence of two azeotropes.

Select *supercrit* if one of the components is supercritical under the given conditions.

3 liq.phases specifies the co-existence of three liquid phases.

Sep.Fac.~1.0 is a qualitative statement that the separation factor is near 1.

Measurement Method: If the measurement method is unknown or none of the listed, then the first entry in the list should be selected.

Otherwise select *Distillation* if the information has been obtained by distillation or choose *Phase Equilibrium* (based on phase equilibrium measurements).

Reaction: If the system is reactive select *Yes*, otherwise *No* should be chosen.

Evaluated by: The *Evaluated by* field contains information about the person and how the data has been gained. Leaving the first entry unchecked means the evaluation has been done by the author.

If the data has been published as table or in a graphical representation choose the corresponding check box.

Select *VLE* if the information has been provided as VLE data. If the information has been extracted by fitting to published VLE data, then *fitted* should be selected. If furthermore the information has been calculated using the fitted parameters obtained by the published VLE data, then *calculated* should be activated.

Precision: The precision of a measured value can be specified using the according drop-down list. ‘=’ denotes exact, ‘<’ denotes lower than, ‘~’ denotes about, ‘>’ denotes higher than and ‘?’ denotes a dubious value.

The dialog allows entering several temperature, pressure, and composition points for the current reference and system. Since the data bank itself just stores single points a data set for each point will be created.

4.6. ACT – Activity Coefficients at Infinite Dilution (Binary Systems)

Select the ACT tab to edit activity coefficients at infinite dilution data for binary systems.

The first listed component of the system will be interpreted as *solute*, the second component will be assumed to be the *solvent*. The selected classification will be displayed.

Solute	3-Methylhexane
Solvent	Heptadecane

Besides the activity coefficient at infinite dilution a temperature has to be specified.

- 0 - prediction
- 1 - GLC (with gas phase correction)
- 2 - GLC (without gas phase correction)
- 3 - LLC
- 4 - ebulliometry
- 5 - dilutor
- 6 - static method
- 7 - GLC (not specified)
- 8 - GLC (relative method)
- 9 - other techniques
- 10 - calculated from Henry coefficients
- 11 - GLC (mean values at average temperature)
- 12 - GLC (non steady state method)
- 13 - Rayleigh distillation method
- 14 - calculated from solubility data
- 15 - calculated from phase equilibria

It is also possible to state the *Measurement Method* that has been used to obtain the activity coefficient. If the method is unknown or none of the listed, then *other techniques* should be selected.

There are several predefined experimental methods like GLC (including specializations), LLC, ebulliometry, dilutor and the Rayleigh distillation method.

If the value has been calculated either the general prediction or the calculated from Henry coefficients can be selected.

Currently every data set contains only one data point. However, it is possible to type more lines. Every line typed here will become a separate data set. It is not possible to load the typed line simultaneously.

4.7. ACM – Activity Coefficients at Infinite Dilution (Ternary Systems)

Select the ACM tab to edit activity coefficients at infinite dilution data for ternary systems.

Here the *third* listed component of the system will be interpreted as *solute*. The first two components will be assumed to be the *solvent system*. The right selection can be validated inspecting the *Solvents* and *Solute* field where the DDB component numbers will be displayed.

For any data point a temperature, the composition (for the first component) and the activity coefficient itself has to be specified.

For the entire data set a *measurement method* can be specified.

4.8. HE – Heats of Mixing Data

Excess enthalpy data (heats of mixing) can be edited using the HE tab. The maximum number of components in the system is five.

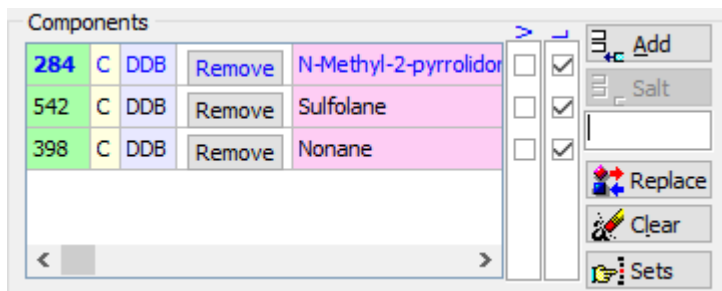

For any selected component the original state before mixing has to be specified. If the component has been liquid, 'L' has to be selected (default). If the component has been in the vapor state, then 'V' should be activated.

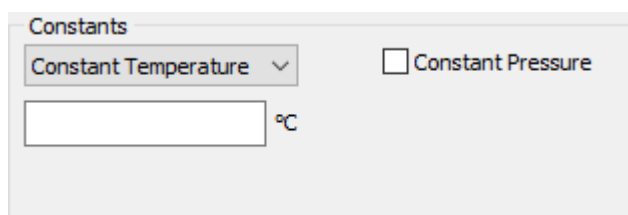

For *binary systems* it is possible to edit either data with a constant composition as environment condition or to specify a constant temperature. For ternary systems and higher only the latter may be specified.

If a *constant temperature* is given its value has to be entered. Furthermore for any data point the excess heat and the composition (in mole fraction) has to be specified.

If a *constant composition* (mole fraction of the first component) is given, then for any data point the excess heat and a temperature has to be specified.

None (split data set) is chosen if no constant value is given. Every data point is saved as an individual isothermal data set.

A *constant pressure* may be stated by selecting the corresponding checkbox and entering a valid pressure within the chosen pressure unit.

J/mol
kJ/mol
cal/mol
kcal/mol

There are four possible *units* for the specified h^E data.

Miscibility Gap

For isothermal data it is possible to state the existence of a *miscibility gap* under the given conditions (temperature and pressure, if given).

4.9. VE – Excess Volumes and Densities

Select the VE tab to edit excess volumes data (volume effects of mixing), densities, and volumes of mixtures. The options and restrictions are nearly the same as for mixing enthalpies (HE) except the possibility to set the data type.

- Excess volume [cm³/mol]
- Density [g/cm³]

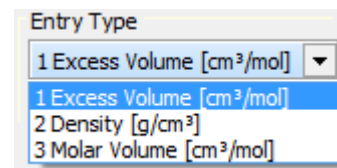

- Volume [cm³/mol]

The “Statistics” button shows the number data sets and point for the three properties.

4.10. CPE – Excess Heat Capacities

To edit excess heat capacities and heat capacities of mixtures the CPE tab has to be selected. The options and restrictions are nearly the same as for HE except the possibility to set the data type.

- Excess heat capacity “cp^E” in different units
- Heat capacity “cp” in different units

The “Statistics” button shows the number of data sets and points for both properties.

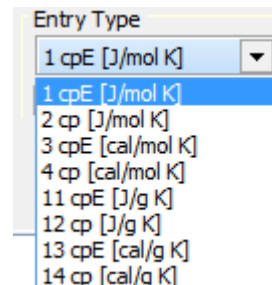

4.11. GLE – Gas Solubility Data

Gas solubility data can be edited by selecting the GLE tab.

This database doesn't use the temperature and pressure selection from the Units/Quality dialog because it stores the original units inside the database.

Currently one gas in up to three solvents may be specified. The first component will always be assumed to be the gas. So the maximum number of components in the system is four.

- 1 - Pressure (Gas)
- 2 - Pressure (total)
- 3 - Temperature

Constant Property: It is necessary to specify an environment condition. It is possible to choose between a partial pressure, a total pressure or a temperature value.

If a (partial or total) pressure has been selected as environment condition, then a temperature has to be specified for any data point. If a constant temperature has been specified, then it is possible to select partial pressure, total pressure or fugacity as table value.

Independent from being specified as constant or table value one of the various units has to be selected both for the pressure and for the temperature value(s).

The *Table Value* group can be used to customize the number and contents of the data table columns. Besides a temperature/pressure value up to two values may be specified.

- 1 - coeff.
- 3 - coef, ygas
- 4 - coef, xliquid
- 5 - coef, xliquid (gasfree)
- 7 - coef, wt%liquid
- 8 - coef, wt%liquid (gasfree)
- 9 - coef, kmol/m³

If there is one gas in one solvent given, then it is possible to specify the mole fraction of the gas in the vapor phase (selecting entry 3).

For two or more solvents the composition in the liquid phase must be specified. Choose entry 5 for mole fraction and entry 9 for kmol/m³ as unit. Usually the *real* mole fraction of all but the last solvent should be specified if either solubility coefficient no. 10 or no. 12 is selected (see below). Otherwise the *gas-free* mole fraction should be specified.

10 - X gas *10⁴

- 11 - mole gas/mole solvent
- 12 - X gas
- 13 - mole gas/mole solv.1
- 20 - Henry co. (P)
- 21 - Henry co. (F)
- 22 - Henry co. (P)/1000
- 24 - Pgas /Cgas [mol/dm³]
- 25 - Pgas /Cgas [mol/cm³]
- 30 - Ostwald co. [cm³/dm³]
- 31 - Ostwald co. [cm³/cm³]
- 40 - Kuenen co. [Ncm³/g]
- 41 - Kuenen co. [Ncm³/kg]
- 42 - Ncm³/g
- 50 - Bunsen co. [Ncm³/cm³]
- 51 - Bunsen [Ncm³/cm³]*100
- 52 - Bunsen co. [Ncm³/dm³]
- 60 - mole gas/g solvent
- 61 - mole gas/g solv.*10⁷
- 62 - mole gas/dm³ solvent
- 63 - mole gas/m³ solvent
- 64 - mole gas/1000 g solv.
- 70 - mg gas/kg solvent
- 80 - lamda [Ncm³/g/at]
- 90 - mole gas/mole amine

A solubility coefficient has to be specified. There are several different coefficient types that can be used. Please select the appropriate from the *Coefficient* list.

0 - unknown

- 1 - direct method
- 2 - pressure or volume difference
- 3 - comparative method
- 4 - gaschromatographic
- 5 - saturation method
- 6 - chemical (titration)
- 7 - capillary cell method
- 8 - static method
- 9 - microgasometric method
- 10 - piezometric method
- 11 - dilutor method
- 12 - phase equilibrium measurement
- 13 - other method
- 14 - gas-stripping method
- 15 - modified gas-stripping method
- 16 - integrated gas-stripping method

Finally a *Measurement Method* can be specified. If the method has not been published, then *unknown* should be selected. If the used method is not in the list, then *other method* should be chosen.

4.12. ELE – Vapor-Liquid Equilibrium Data of Electrolyte Systems

Select the ELE tab to edit vapor-liquid equilibrium data of electrolyte systems.

The ELE data bank allows to store information about systems containing up to four solvents and up to four salts. So the maximum number of components in the system is eight.

The field *Data Set Entries* describes how measured quantities may be combined to be processed. For ternary systems and higher (at least two solvents and at least one salt) the data types lower than 20 and in the thirties have to be used because they allow to specify a solvent composition. For binary systems (single solvent) the data types between 21 and 29 and higher than 40 must be used.

1 -	xs	y	P	Constants:	T conc
2 -	xs	y	T	Constants:	P conc
3 -	xs		P	Constants:	T conc
4 -	xs		T	Constants:	P conc
5 -	xs	y		Constants:	T conc
6 -	xs	y		Constants:	P conc
7 -		y	P	Constants:	T conc
8 -		y	T	Constants:	P conc
9 -	xs	y	T P	Constant:	conc
11 -	xs	y	conc P	Constant:	T
12 -	xs	y	conc T	Constant:	P
13 -	xs		conc P	Constant:	T
14 -	xs		conc T	Constant:	P
15 -	xs	y	conc	Constant:	T
16 -	xs	y	conc	Constant:	P
17 -		y	conc P	Constant:	T
18 -		y	conc T	Constant:	P
19 -	xs	y	conc T P		
21 -	conc		P	Constant:	T
22 -	conc		T	Constant:	P
23 -	conc	osm. coeff.		Constant:	T
24 -	conc	osm. coeff.		Constant:	P
25 -	conc	gamma+-		Constant:	T
26 -	conc	gamma+-		Constant:	P
29 -	conc		T P		
31 -	xs	y	P	Constant:	T sat.
32 -	xs	y	T	Constant:	P sat.
33 -	xs		P	Constant:	T sat.
34 -	xs		T	Constant:	P sat.
35 -	xs	y		Constant:	T sat.
36 -	xs	y		Constant:	P sat.
37 -		y	P	Constant:	T sat.
38 -		y	T	Constant:	P sat.
39 -	xs	y	T P	Constant:	sat.
43 -	T	osm. coeff.		Constant:	sat.
44 -	P	osm. coeff.		Constant:	sat.
45 -	T	gamma+-		Constant:	sat.
46 -	P	gamma+-		Constant:	sat.
49 -	T		P	Constant:	sat.
51 -	conc	diss.grade	P	Constant:	T
52 -	conc	diss.grade	T	Constant:	P
53 -	conc	diss.grade	osm. coeff.	Constant:	T
54 -	conc	diss.grade	osm. coeff.	Constant:	P
55 -	conc	diss.grade	gamma+-	Constant:	T
56 -	conc	diss.grade	gamma+-	Constant:	P
59 -	conc	diss.grade	T P		
63 -	conc	P	osm. coeff.	Constant:	T
64 -	conc	T	osm. coeff.	Constant:	P
65 -	conc	P	gamma+-	Constant:	T
66 -	conc	T	gamma+-	Constant:	P

Figure 14: ELE Data Types

The abbreviation *xs* means the liquid solvent mole fraction (salt-free), *y* represents the vapor mole fraction, and again *T* is for temperature (in °C) and *P* is for pressure (in kPa). For binary systems a molal osmotic coefficient (*osm. coeff.*) or a mean molal activity coefficient (*gamma+-*) may be specified.

- 1 - <m> mole salt/1000g solvent
- 2 - <w%> weight% salt
- 3 - <Z> mole fraction salt
- 4 - <X3> mole fraction salt
- 5 - <M> mole salt/liter solvent

Concentration Scale: The abbreviation *conc* in the data set entries list denotes the salt concentration. The selection list *Concentration Scale* can be used to select the desired unit. There are currently five different concentration units available. The units <m>, <w%> and <M> are self-explanatory. If the salt concentration is given in mole fraction without considering the charge of ions, then <Z> should be selected. The concentration unit <X3> is defined by the mole fraction of ions:

$$X_3 = \frac{n_3}{n_1 + n_2 + v n_3}$$

n: moles (n_1 , n_2 for solvents, n_3 for salt)

v: moles ions (referring to one mole completely dissociated salt – e.g. 2 for NaCl)

The value of the constant measured quantity (depending on the selected data type) has to be entered next to the *Concentration Scale* selector.

4.13. POW – Octanol-Water-Partition Coefficients

A data point in this database contains

- Temperature
- Logarithmic (base 10) partition coefficient of a single component in the Octanol/Water system
- pH value of the liquid phase
- Experimental error (in log P_{ow} units)
- Measurement method (Normally unused, only predicted values should be marked)
- Quality code.

A data set contains only single points.

4.14. EGLE – Gas Solubilities in Electrolyte Containing Systems

The EGLE database structure is the same as the GLE database. Salts and electrolytes are stored not with their special salt number but with their 'normal' component code.

Another slight difference is that reference links are not needed for this database since the normal literature numbers (LEAR) are used directly.

4.15. CRI – Critical Data of Mixtures

The CRI database contains temperatures, pressures, densities and compositions describing critical, near-critical or pseudo-critical information of mixtures.

The composition can be given in

- 1 MolePercent <100>
- 2 MoleFraction <1 >
- 3 VolumePercent <100>
- 4 VolumeFraction <1 >
- 5 MassPercent <100>
- 6 MassFraction <1 >
- 7 Mole <>
- 8 kg <>
- 9 g <>

The numbers in angle brackets are used as conversion factors.

The concrete type of critical data has to be specified by the “State” selection box:

State
0 Not specified

The complete list of states:

State No.	Short Term	Description/Transition
0	Not specified	no specification on present/vanishing phases given
1	Liquid-vapor	Liquid-vapor to vapor/gas (VL > V/G)
2	UCEP	Upper critical end point
3	LCEP	Lower critical end point
4	Liquid-liquid	Liquid-liquid to liquid (LL > L)
5	to be defined	no specification on present/vanishing phases given
6	univariant (undef. phases)	Univariant line (present/vanishing phases not explicitly defined)
7	VLL	Vapor-liquid-liquid to two phases (VLL > VL, VLL > LL)
8	DCEP	Double critical end point
9	SVL TP	Solid-vapor-liquid (univariant) temperature/pressure data
10	VLL TP	Vapor-liquid-liquid (univariant) temperature/pressure data
11	Gas-gas	Gas-gas to gas (GG > G)
12	Near crit. TP (2PHS)	2-Phase temperature/pressure point near critical point
13	Univariant SLLV	Univariant point or data, solid-liquid-liquid-vapor phases
14	VL1L2L3	Vapor-liquid1-liquid2-liquid3 to three phases (VLLL > VLL, VLLL > LLL)
15	LLL > LL	Liquid-liquid-liquid to two phases (LLL > LL)
16	LLS TP	Solid-liquid-liquid univariant temperature/pressure data
17	S1S2LV TP	Solid-solid-liquid-vapor univariant temperature/pressure data
18	CST (LLE)	Critical solution temperature (LL>L)
19	LCST (LLE)	Lower critical solution temperature (LL>L)
20	UCST (LLE)	Upper critical solution temperature (LL>L)
21	SL1G	Solid-Liquid1-Gas univariant temperature/pressure data
22	SL2G	Solid-Liquid2-Gas univariant temperature/pressure data
23	LL > L	Transition from two to one liquid

State No.	Short Term	Description/Transition
24	HL1L2	Hydrate-liquid-liquid (univariant) temperature/pressure data
25	HL1G	Hydrate-liquid-vapor/gas (univariant) temperature/pressure data
26	Quadruple point	Four phases present under given (univariant) conditions
27	Structural transition point	Hydrate I to Hydrate II transition
28	L1L2S2 TP	Liquid-liquid-solid-temperature/pressure data
29	K-point (L1-L2=V)	Liquid-liquid to liquid-vapor (L1L2>L1V)
30	HL1L2V	Hydrate-liquid-liquid-vapor (univariant) temperature/pressure data
31	HL2G	Hydrate-liquid-vapor/gas (univariant) temperature/pressure data
32	HIceG	Hydrate, Ice, Gas
33	SSG	Solid, Solid, Gas
34	SLF	Solid, Liquid, Fluid

The “Table Entries” selection drop-down-boxes allow to define up 7 columns. Beside the main data types it is possible to add errors for them.

For every table entry it is necessary to define the unit.

Table Entries	Units
1 T Temperature	1 K
51 ET Error in Temperature	1 K
2 P Pressure	6 MPa
52 EP Error in Pressure	6 MPa
4 D Density	2 kg/m ³
54 ED Error in Density	2 kg/m ³
0 Not available.	

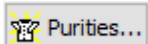
The button  opens a dialog where the purities of the used pure component properties can be specified.

The “Purity Type” selection menu contains the following entries:

- 0 Not specified
- 1 Weight Percent
- 2 Volume Percent
- 3 Mol Percent
- 4 Area Percent
- 5 Refractive Index
- 6 Percent

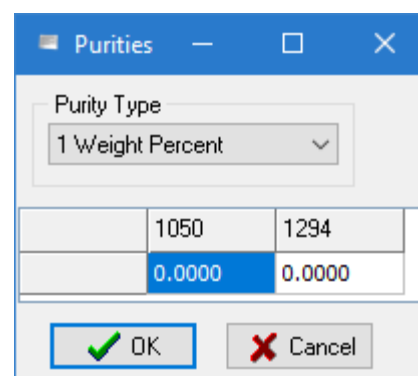

The dialog box titled "Purities" has a "Purity Type" dropdown menu set to "1 Weight Percent". Below it is a table with two columns and two rows. The first row contains the values "1050" and "1294". The second row contains "0.0000" and "0.0000", with the first cell highlighted in blue. At the bottom, there are "OK" and "Cancel" buttons.

	1050	1294
	0.0000	0.0000

Figure 15 Purities

Additional entries are a measurement method and an unspecified comment.

The data are stored in original units and in original notation.

4.16. ESLE – Salt Solubilities

The ESLE database contains information on the solubility of salts and electrolytes in pure components and mixtures.

The common component/salt list has to be separated in solved and precipitated components and solved and precipitated salts.

Components		Salts	
174	<input checked="" type="checkbox"/> Solved <input type="checkbox"/> Precipitated	1000052	<input checked="" type="checkbox"/> Solved <input checked="" type="checkbox"/> Precipitated
		1000104	<input checked="" type="checkbox"/> Solved <input checked="" type="checkbox"/> Precipitated
		1000115	<input checked="" type="checkbox"/> Solved <input type="checkbox"/> Precipitated

Figure 16 Solved/Precipitated Classification

The salts are shown with their salt number increased by 1 million to make them easily identifiable. This component are can be hidden by pressing the  button. The button’s caption and duty changes to

“Show Components” in this case.

A ESLE data set also contains information in the measurement method.

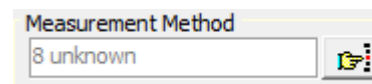

It is possible to define a constant temperature and a constant pressure. For both properties it is necessary to define the unit.

Pressure and temperature can either be constant or in the data table when they change for every data point.

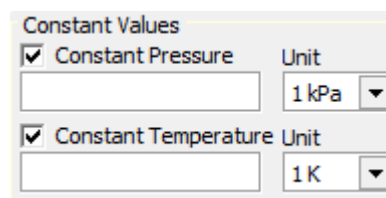

The data table can be build from the selection box “New Table Entry”.

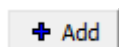

 Adds a new column

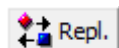
 Changes the currently selected column

 Clears the entire grid

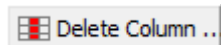

Deletes a column specified in a pop-up menu:

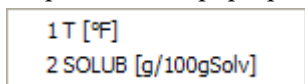

Possible table entries are

- Temperature
- Pressure
- Salt solubility (SOLUB) in molar and mass based units
- Solvent composition (COMPOS)
- Component and salt number of precipitated component or salt (SALT_PREC, COMP_PREC)
- Time needed for equilibrium (EQTIME)
- Liquid density (LIQDEN)
- Salt solubility (SOLUBV) in volume based units
- Component solubility (SOLUBC)

```

1 T
2 P
3 SOLUB
4 COMPOS
5 SALT_PREC
6 COMP_PREC
7 EQTIME
8 LIQDEN
9 SOLUBV
10 SOLUBC
    
```

Experimental data are stored in original units.

A special feature is the possibility to read and save a tagged file format. These files must have the extension “.sle” and are pure text files.

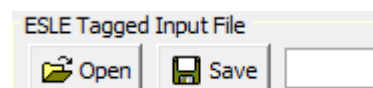

4.17. AAE – Adsorbent/Adsorptive Equilibria

The AAE database contains data on standard components adsorbed on zeolites, coals, molecular sieves etc. The database content is specified by data type number.

Datatype	Description
Pure Adsorptives	
11	isothermal data (temperature = constant)
12	isostere data (amount = constant)
13	isobaric data (pressure = constant)
Binary Adsorptives	
21	isobaric data (pressure, temperature = constant)
22	isothermal data (vapor phase mole fraction, temperature = constant)
23	isothermal data (relative saturation with water, temperature = constant)
24	isothermal data (volume ratio at the beginning, temperature = constant)
25	isothermal data (pressure is nearly constant, temperature = constant)
Ternary Adsorptives	
31	variation of the total pressure and fixed vapor composition (Y_i , temp. = constant)
32	constant total pressure and constant vapor composition ratio (pres., temp., one Y_i = constant)
33	constant total pressure and constant vapor composition ratio (pres., temp., all Y_i = constant)
34	constant total pressure (pressure, temp. = constant)

Datatype	Description
35	variation of total pressure at constant partial pressure of water as component (temp., YH2O= constant)
36	constant volume ratio of adsorptives at the beginning of the measurement (temp., beginning volume ratio = constant)
37	only constant temperature (temperature = constant)

These data types determine the content of the data table.

Adsorbent Details

15

The adsorbent is defined by two entries. One number is a coarse specification of the adsorbent type, zeolite x, activated carbon etc. This number is selected in the common components/salts/adsorbents list of EditMixtureData. The other number references an entry in an adsorbent details list where quantitative data for the special adsorbent is specified.

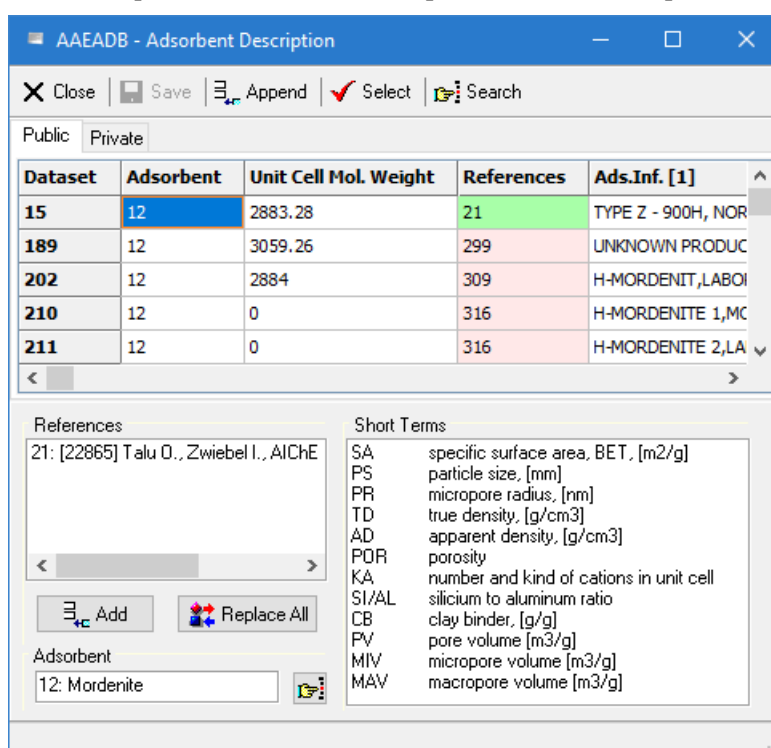

Figure 17 Adsorbent Details

This adsorbent details list contains:

1. Adsorbent number (class)
2. Unit cell molecular weight – if available
3. Reference number/s
4. Four fields with details. These fields are pure text, but contain some tags listed in the “Short Terms” box. For some historic reasons empty fields are filled with the string “E-M-P-T-Y”.
5. Two text fields reserved for kinetic information – which are currently unused.

An item can be selected by selecting the “Select” button or by double-clicking the appropriate line.

The database contains information on adsorption and desorption. The process type has to be specified in the “Data Type” radio box.

Data Type
 Adsorption
 Desorption

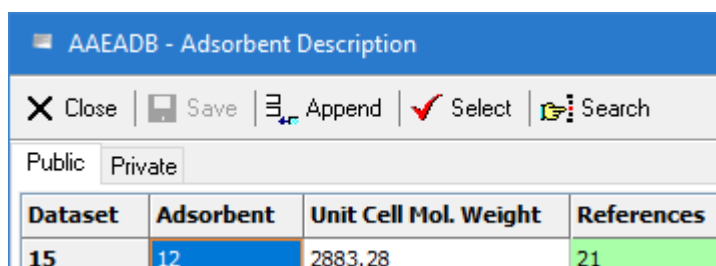

Dataset	Adsorbent	Unit Cell Mol. Weight	References
15	12	2883.28	21

The “Original Unit” selection boxes specify the units of pressure, temperature, and amount in the original publication. The database itself only stores temperatures in [K], pressures in [kPa], and adsorbed amounts in [mmol/g].

4.18. Polymers

The polymer data bank contains

- Vapor-liquid equilibria
- Liquid-liquid equilibria (mixing gaps)
- Solubilities
- Excess and dilution enthalpies
- Densities and volumes
- Swelling
- Partition coefficients
- and few other data

for polymers and polymer containing systems.

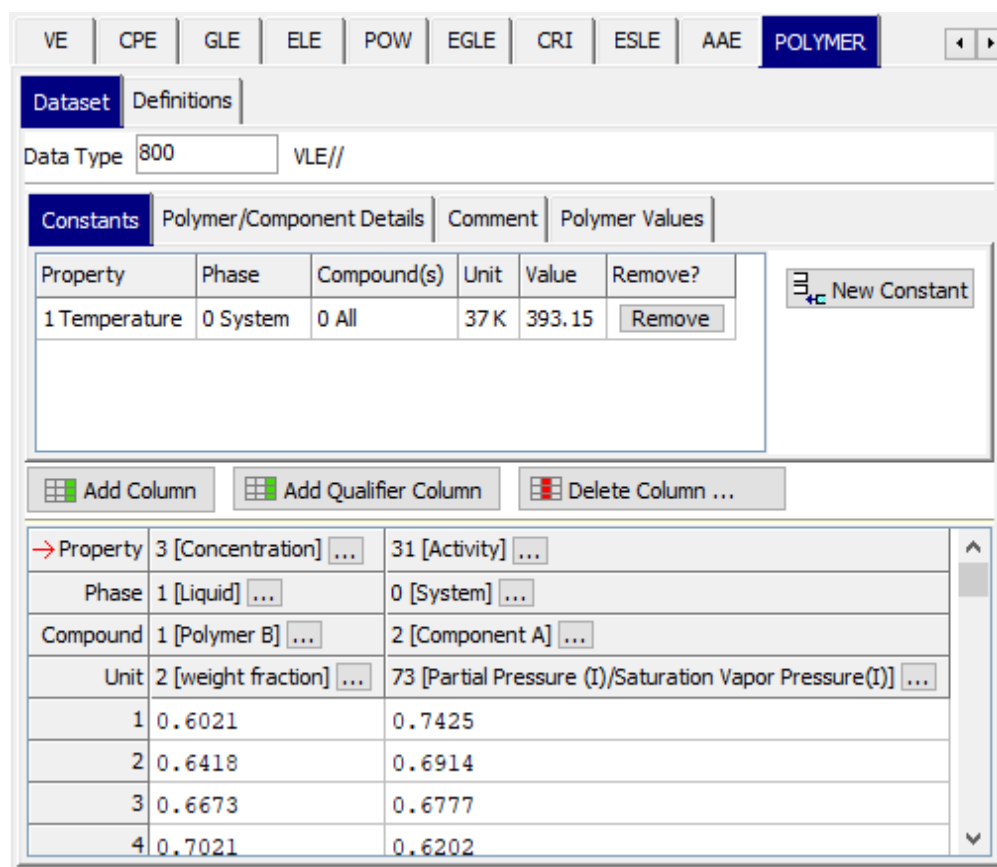

Figure 18: Polymer Data Set Editor

The “Data Type” is a number specifying the properties of the data set. The edit field has a context menu where available data types are listed.

This data type does describes the content of the data set but the table items can be selected independent of this number. This is a possible pitfall since table items might be specified which have no meaning for the specified data type.

Constants

A polymer data set might contain as many constants as needed.

A constant is defined by its property, phase, related components, a unit, and its value. All data have to be entered via context menus.

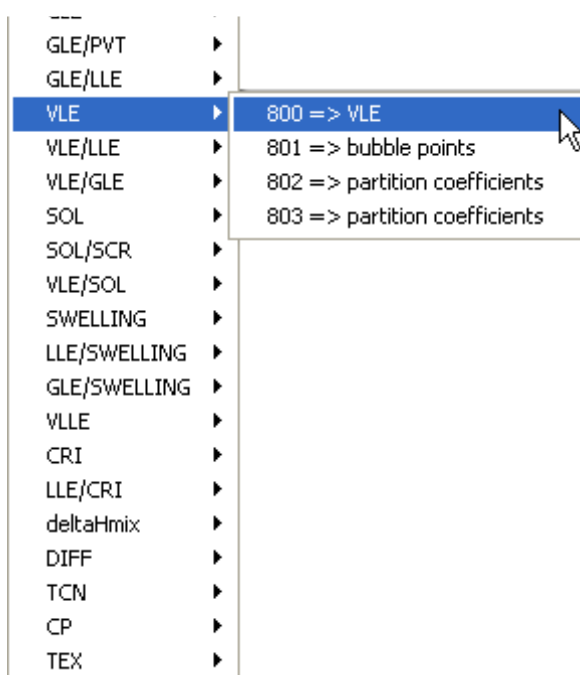

The image displays three screenshots of software dropdown menus. The top-left menu lists options from -1 to 12, with '8 - Concentration Range (from) - from C' selected. The top-right menu lists options from -1 to 11, with '4 - Liquid (Gel) -' selected. The bottom-left menu lists options from 0 to 22, including '0 - All', '1 - Polymer B', and '22 - Polymer B and Solvent A'. The bottom-right menu lists numerical options from 1 to 16, representing different units such as '1 [mole fraction]' and '2 [weight fraction]'.

The component description is not a direct relation to a specific components but rather a sort of index. This index (“Polymer B”, “Additive A” etc.) are specified in the “Polymer/Component Details” page.

Constants		Polymer/Component Details		Comment		Polymer Values			
#Polymer/Comp't	#Index	WMN	WMW	WMZ	WMETA	Polydispersity Index	Additional Info.	Additional Info.	Trade Name
3000004	1 Polymer B	1710	3710			2.16959064327485			polyethene
27	2 Component A								

This table also allows to enter several details for the polymers like mean molecular weights and a polydispersity index. Two fields are reserved for any additional information and one field is for a trade name.

The “#Index” column is used for specifying a component or polymer specific index and the entries are selected via context menus.

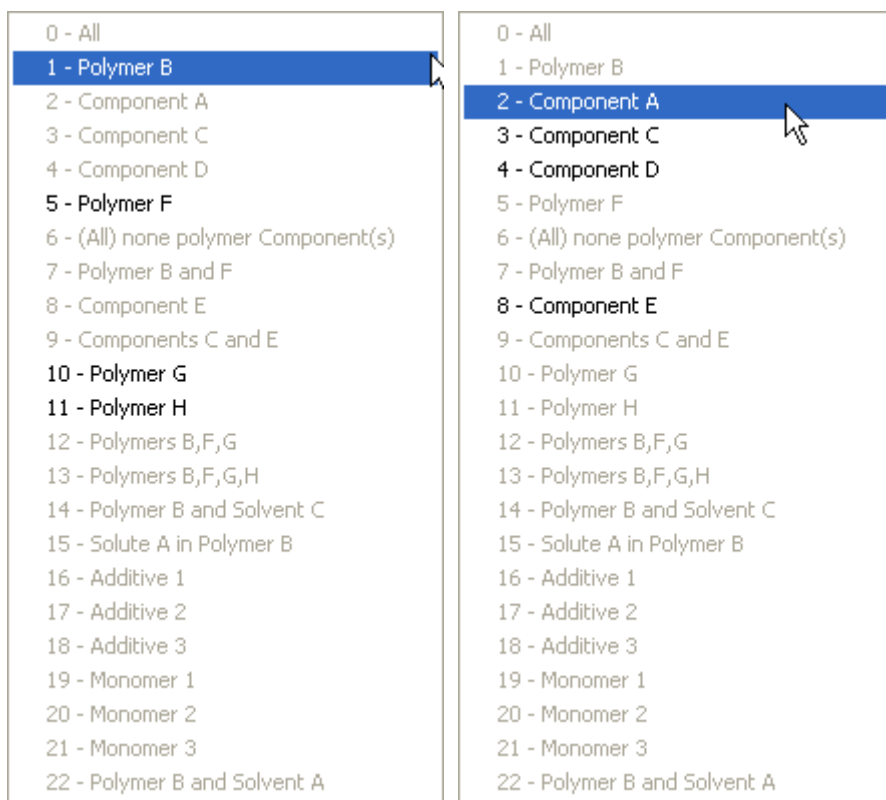

Only valid entries are selectable. The “Comment” page is a place for entering arbitrary text which does not fit into any other place.

Constants	Polymer/Component Details	Comment	Polymer Values
<div style="border: 1px solid gray; padding: 5px; min-height: 80px;"> This is an arbitrary comment </div>			

The “Polymer Values” is twin of the “Constants” page but intended for polymer specific values only.

Constants		Polymer/Component Details		Comment		Polymer Values	
#Index	Property	Unit	Value	Remove?			
1	Polymer B	30 Reaction Rate	57 1/s	658	Remove		
						New Value	

Specifying the Columns of the Table

The buttons

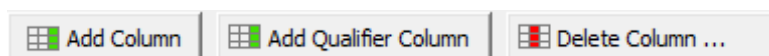

allow to add and remove columns. The “Add Column” function adds always the same column type:

These four entries represent the property, the phase, the compound or compounds, and the unit of the property. The ellipsis buttons allow to change the values by context

3 [Concentration] ...
1 [Liquid] ...
1 [Polymer B] ...
2 [weight fraction] ...

menus.

The adds a special column containing only unspecified values,

text or numbers. Only a single qualifier column can be added.

The button displays a context menu with the

column numbers.

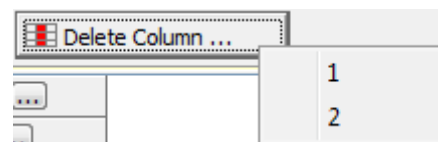

Exploring the Definition Lists

The polymer data bank uses in several cases indexes instead of a complete and repeated storage of some data.

Polymer Components		Polymer Datatypes	Polymer Phases	Polymer Properties	Polymer Units
Index	Component Specification				
0	All				
1	Polymer B				
2	Component A				
3	Component C				
4	Component D				
5	Polymer F				

The index numbers are pointing to entries in the definition lists for

- Component Specification (index code)
- Data Types (like VLE, LLE, SLE, etc.)
- Phases (liquid, vapor, solid, etc.)
- Properties (Temperature, Concentration, etc.)
- Units (specific lists for all properties)

These lists are currently not extendable.